



AT93000 Utility Box

AT93000 Utility Box Manual 20220812b



Copyright © MultiLane Inc. All rights reserved. Licensed software products are owned by MultiLane Inc. or its suppliers and are protected by United States copyright laws and international treaty provisions.

Use, duplication, or disclosure by the Government is subject to restrictions as set forth in subparagraph (c)(1)(ii) of the Rights in Technical Data and Computer Software clause at DFARS 252.227-7013, or subparagraphs (c)(1) and (2) of the Commercial Computer Software -- Restricted Rights clause at FAR 52.227-19, as applicable.

MultiLane Inc. products are covered by U.S. and foreign patents, issued and pending. Information in this publication supersedes that in all previously published material. Specifications and price change privileges reserved.

General Safety Summary

Review the following safety precautions to avoid injury and prevent damage to this product or any products connected to it. To avoid potential hazards, use this product only as specified.

Only qualified personnel should perform service procedures.

While using this product, you may need to access other parts of the system. Read the General Safety Summary in other system manuals for warnings and cautions related to operating the system.

To Avoid Fire or Personal Injury

Use Proper Power Cord. Only use the power cord specified for this product and certified for the country of use.

Observe All Terminal Ratings. To avoid fire or shock hazard, observe all ratings and markings on the product. Consult the product manual for further ratings information before making connections to the product.

Do not apply a potential to any terminal, including the common terminal that exceeds the maximum rating of that terminal.

Do Not Operate Without Covers.

Do not operate this product with covers or panels removed.

Avoid Exposed Circuitry. Do not touch exposed connections and components when power is present.

Do Not Operate with Suspected Failures.

If you suspect there is damage to this product, have it inspected by qualified service personnel.

Do Not Operate in Wet/Damp Conditions. Do Not Operate in an Explosive Atmosphere. Keep Product Surfaces Clean and Dry



Caution statements identify conditions or practices that could result in damage to this product or other property.

Table of Contents

Notices.....	2
Table of Contents	3
Table of Figures	3
Utility Box Description	4
Utility Box Dimensions.....	5
Utility Box Subassemblies	6
Utility Box IN/OUT	6
Utility Box Accessories	7
Utility Box Components	7
Installation.....	8
Pneumatic Box Installation.....	8
Electrical Box Installation	8
Storage Box	9
Theory Of Operation	10

Table of Figures

Figure 1: AT93000 Utility Box System Block Diagram.....	4
Figure 2: AT93000 Utility Box Location	4
Figure 3: Mechanical Dimensions.....	5
Figure 4: Top View with doors fully open	5
Figure 5: Subassemblies.....	6
Figure 6: INPUTs / OUTPUTs	6
Figure 7: Accessories	7
Figure 8: Components	7
Figure 9: Installation.....	8
Figure 10: Storage Boxes.....	9

Utility Box Description

The Utility Box¹ should be placed on the ground beside the workstation, it includes all ML systems consisting of subassemblies:

- Electrical Box
- Pneumatic Box
- Storage Box
- Suggested Utility Box location placement show in

Figure 2: AT93000 Utility Box Location

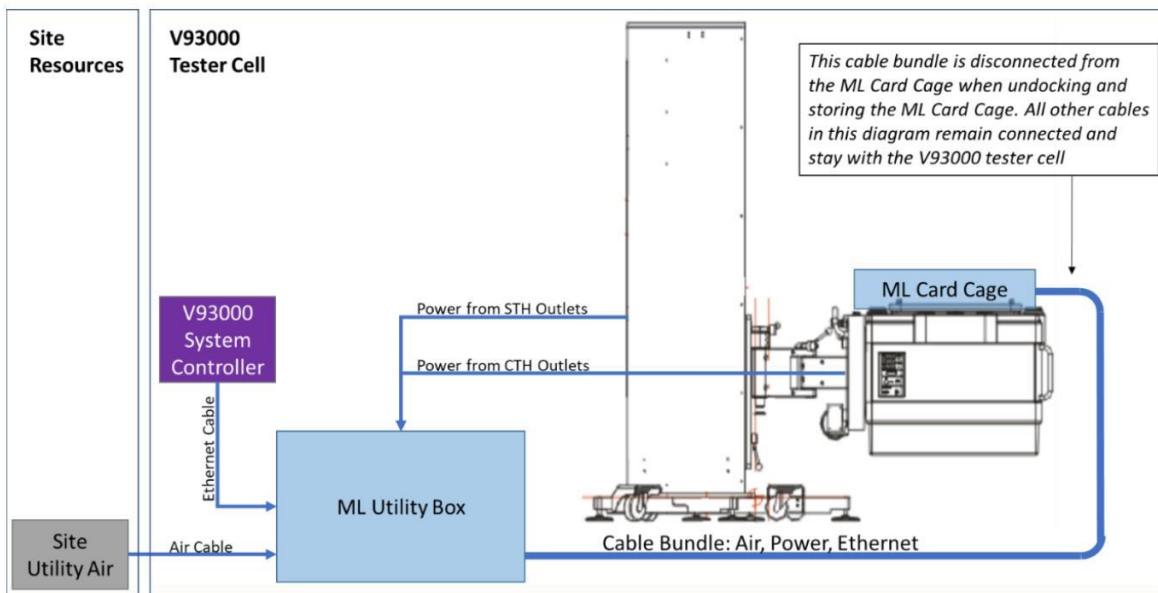

Figure 1: AT93000 Utility Box System Block Diagram

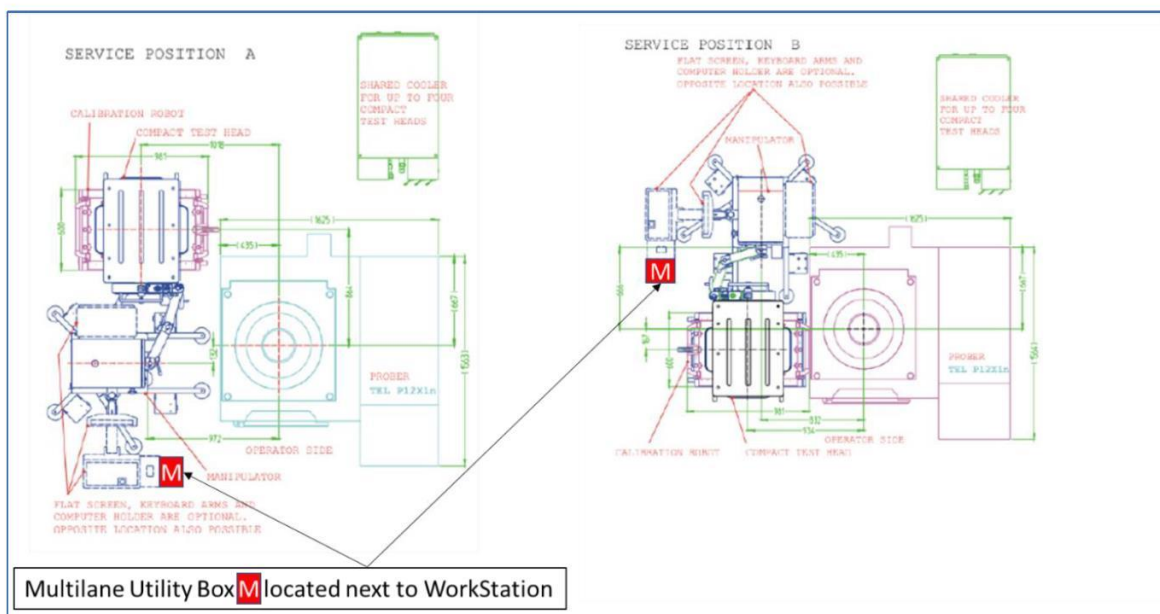

Figure 2: AT93000 Utility Box Location

¹ Part number AT93000-UBOX

Utility Box Dimensions

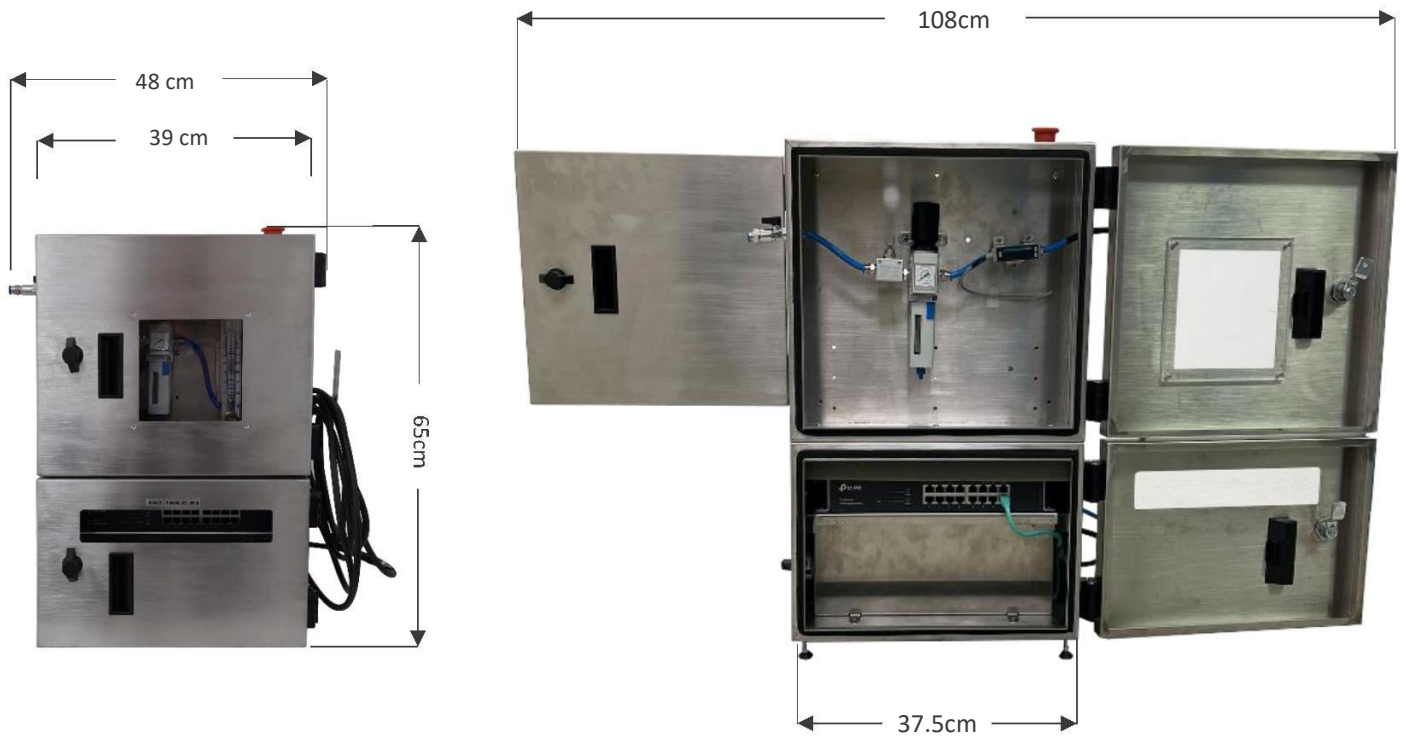

Figure 3: Mechanical Dimensions

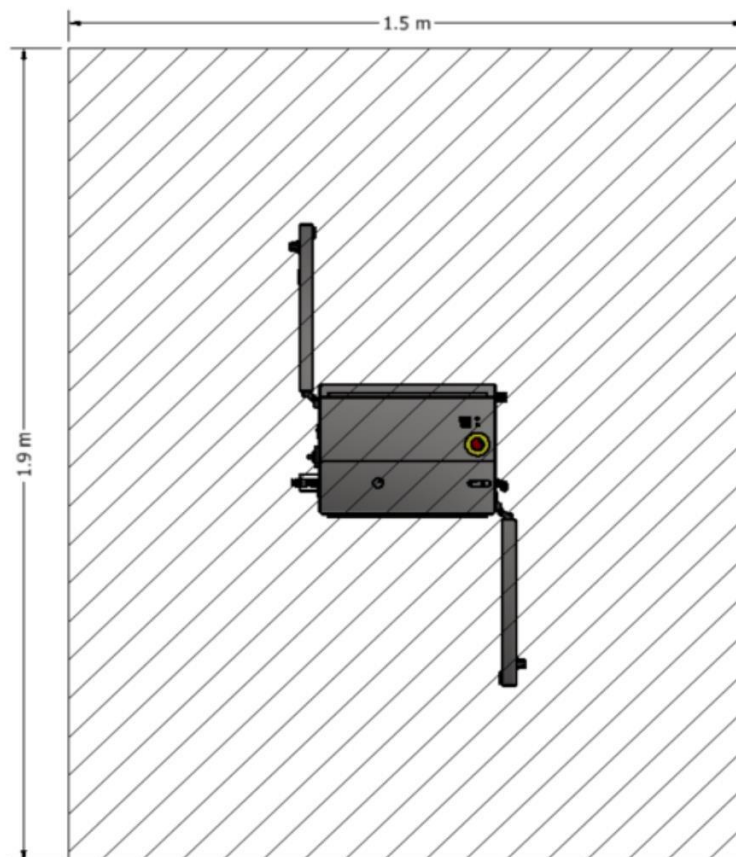

Figure 4: Top View with doors fully open

Utility Box Subassemblies

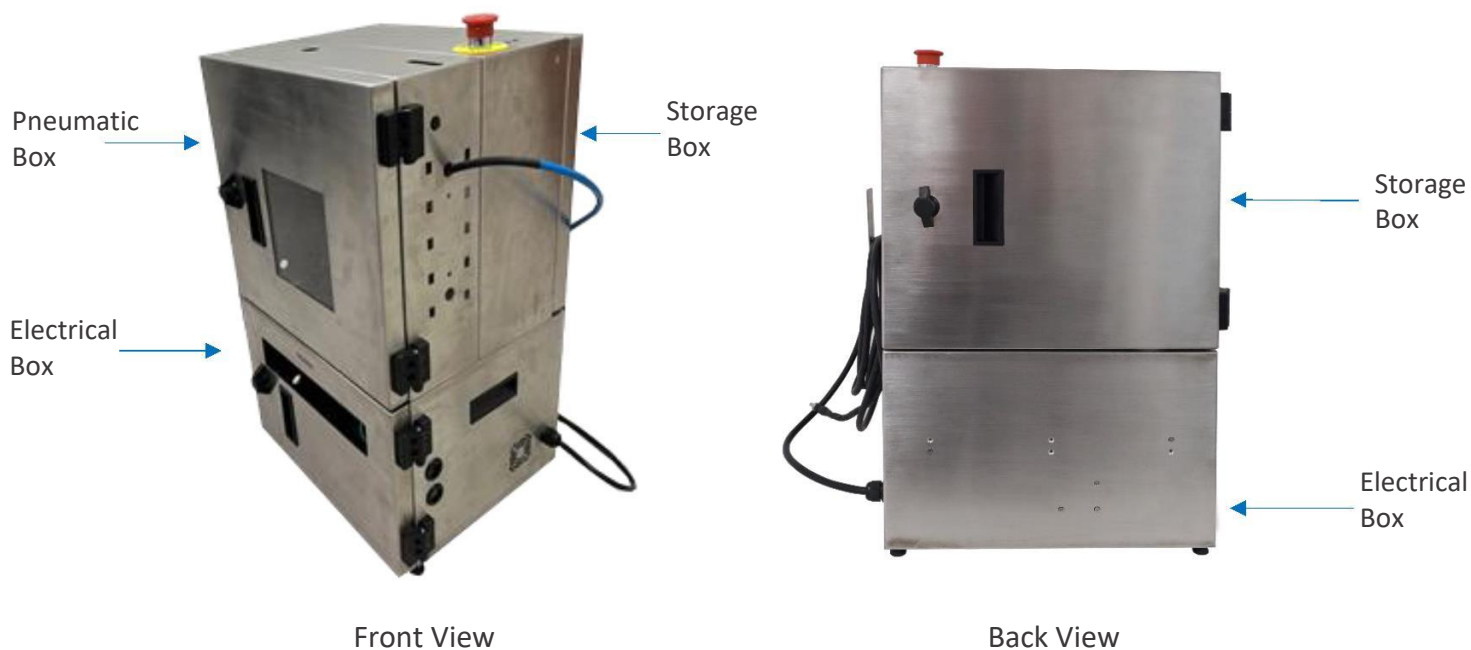

Figure 5: Subassemblies

Utility Box IN/OUT



Figure 6: INPUTS / OUTPUTS

Utility Box Accessories

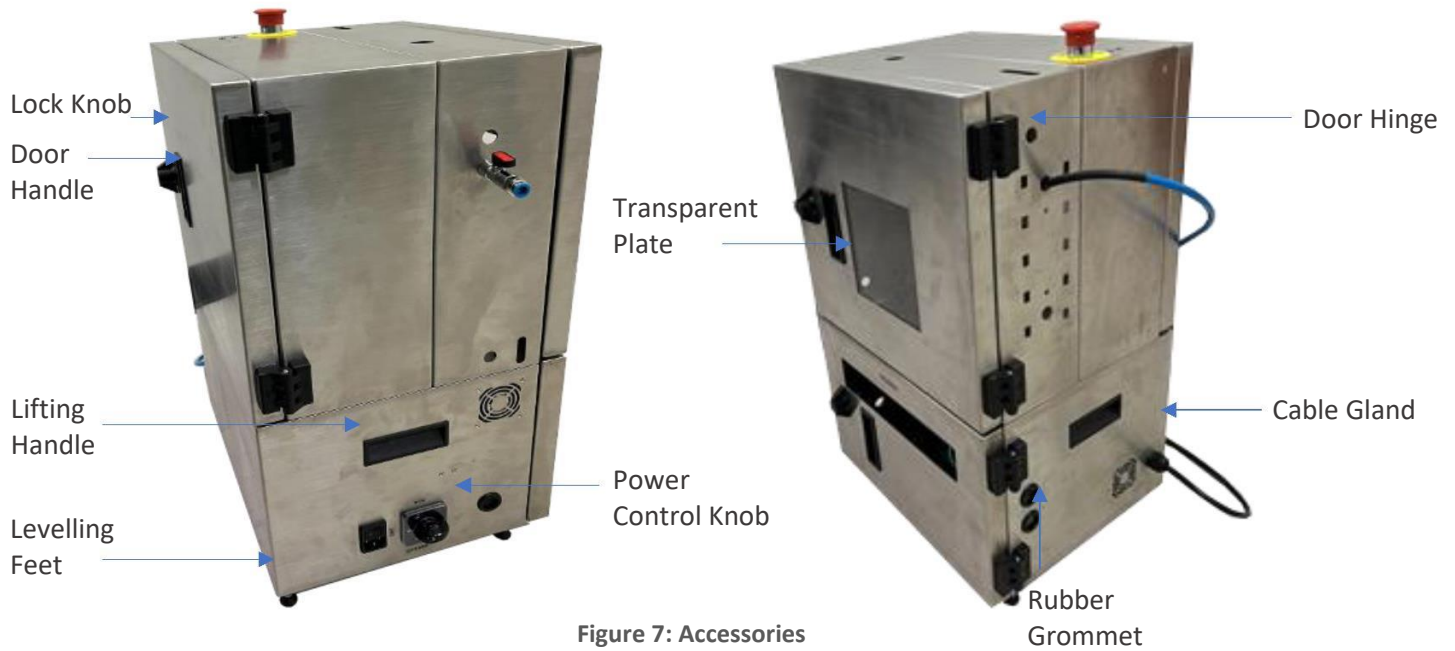

Utility Box Components



Pneumatic Box Installation

Pneumatic Box includes:

1. Filter/Regulator
2. Ball Valve
3. Flowmeter
4. Prepared to include:
 - a. Automatic Drain
 - b. ON/OFF Valve
 - c. Switch between Docking Mechanism and Instruments

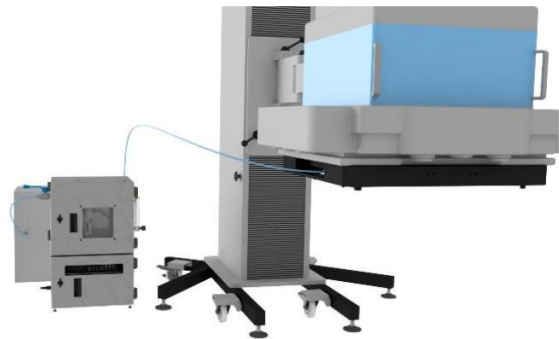
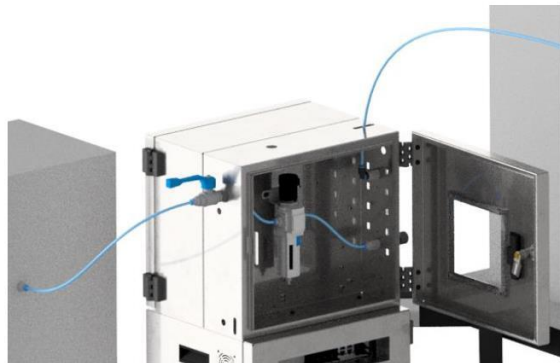

Electrical Box Installation

Electrical Box includes:

1. Switch
2. PDU
3. Power Supply
4. 2x Fans
5. Power Receptacle with ON/OFF Switch and C13 Power Plug
6. 2x Rubber Grommet to pass LAN cables inside
7. 1x Cable Gland to pass power cable inside



Figure 9: Installation

Storage Box

1. Storage Box aims to include all ML accessories and cables not in use.
2. Emergency Button and 2x LEDs placed on top of Storage Box. Cables inside Storage Box are covered for safety.
3. A 3-way Selector Switch for the PDU next to Power Receptacle.



Figure 10: Storage Boxes

Theory Of Operation

1. Connections for the Utility Box:
 - a. See Figure 6: INPUTs / OUTPUTs
 - b. Power cable that comes from the wall to the Utility Box
 - c. Air Cable for the air input (Comes from their air pressure machine into the air input of the Utility Box)
 - d. Plug the air cable (which already exists) from the air output of the Utility Box into the twinning frame
 - e. Plug all ethernets needed into the switch located in the Electrical Box
2. No controls for the power, it has a switch ON and OFF, next to it there is a 3-way Selector Switch for the PDU, explanation below:
 - a. See Figure 6: INPUTs / OUTPUTs
 - b. OFF: you won't be able to turn on the 12 V power supply.
 - c. Bypass: the 12 V power supply will turn on. You will realize that with the sound of the fans they are routed to the 12 V power supply
 - d. PDU: you will need to turn on the PDU using its dedicated GUI, in order to turn on the 12 V power supply
3. No instructions are needed to monitor the airflow regulator. You can monitor the airflow on the sensor while playing with the air regulator
4. For the ethernet cables, one ethernet should be coming from the workstation to the switch, and the 8 ethernet cables from the switch to the faceplates. No need to route the 8 ethernet cables if you don't have 8 instruments, you also have 1 cable plugged between the switch and PDU.
5. The emergency button is used to turn OFF the system if there is a suspected safety issue such as an unusually high cassette temperature reading. The emergency will latch in the OFF position. Pull up on the emergency button to turn system power back ON.
6. Explanation for the 2 LEDs located next to the Emergency button:
 - a. If 1 LED in ON, then the wall power is connected to the Utility Box, but no air is flowing. In this case, there will be no +12 V going to the Twinning Frame
 - b. If both LEDs are ON, then both wall power and airflow are active. In this case, there will be +12 V going to the Twinning Frame.
 - c. Note that if you turn power-ON without turning ON the airflow, there will be no +12 V supplied to the twinning frame and then **ONLY 1** LED will be ON. This safety measure makes sure that the twinning frame instrument cassettes are not power ON without proper cooling from the flow of air across the cassettes. This means that both LEDs should be ON to get +12 V supplied to the twinning frame.